

CONTENTS

4	SAFETY INFORMATION
6	PRODUCT DESCRIPTION
7	CONTROL PANEL
8	PROGRAMMES
10	OPTIONS
11	BEFORE FIRST USE
14	DAILY USE
17	CARE AND CLEANING
18	TROUBLESHOOTING
20	TECHNICAL INFORMATION

ENVIRONMENT CONCERNS

Recycle the materials with the symbol . Put the packaging in applicable containers to recycle it.



Help protect the environment and human health and to recycle waste of electrical and electronic appliances. Do not dispose appliances marked with the symbol  with the household waste. Return the product to your local recycling facility or contact your municipal office.

VISIT OUR WEBSITE FOR:

- Products
- Brochures
- User manuals
- Trouble shooter
- Service information

www.aeg.com

LEGEND

-  Warning - Important Safety information.
-  General information and tips
-  Environmental information

Subject to change without notice

FOR PERFECT RESULTS

Thank you for choosing this AEG product. We have created it to give you impeccable performance for many years, with innovative technologies that help make life simpler – features you might not find on ordinary appliances. Please spend a few minutes reading to get the very best from it.

ACCESSORIES AND CONSUMABLES

In the AEG webshop, you'll find everything you need to keep all your AEG appliances looking spotless and working perfectly. Along with a wide range of accessories designed and built to the high quality standards you would expect, from specialist cookware to cutlery baskets, from bottle holders to delicate laundry bags...



Visit the webshop at:
www.aeg.com/shop

CUSTOMER CARE AND SERVICE

We recommend the use of original spare parts.

When contacting Service, ensure that you have the following data available. The information can be found on the rating plate.

Model _____

PNC _____

Serial Number _____



SAFETY INFORMATION

Before the installation and use of the appliance, carefully read the supplied instructions. The manufacturer is not responsible if an incorrect installation and use causes injuries and damages. Always keep the instructions with the appliance for future reference.

CHILDREN AND VULNERABLE PEOPLE SAFETY



WARNING!

Risk of suffocation, injury or permanent disability.

- Do not let persons, children included, with reduced physical sensory, reduced mental functions or lack of experience and knowledge use the appliance. They must have supervision or instruction for the operation of the appliance by a person who is responsible for their safety. Do not let children play with the appliance.
- Keep all packaging away from children. There is the risk of suffocation and injury.
- Keep all detergents away from children.
- Keep children and pets away from the appliance door when it is open.

INSTALLATION



WARNING!

This appliance must be installed by a qualified or competent person.

- Remove all the packaging.
- Do not install or use a damaged appliance.
- Do not install or use the appliance where the temperature is less than 0 °C.
- Obey the installation instruction supplied with the appliance.
- Make sure that the appliance is installed below and adjacent to safe structures.

Water connection

- Make sure not to cause damage to the water hoses.
- Before you connect the appliance to new pipes or pipes not used for a long time, let the water flow until it is clean.
- The first time you use the appliance, make sure that there is no leakage.

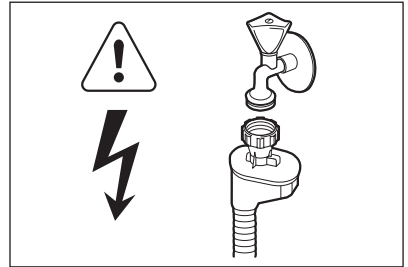

WARNING!

Dangerous voltage.

The water inlet hose has a safety valve and a sheath with an inner mains cable.

- If the water inlet hose is damaged, immediately disconnect the mains plug from the mains socket. Contact Service to replace the water inlet hose.

Electrical connection



WARNING!

Risk of fire and electrical shock.

- The appliance must be earthed.
- Make sure that the electrical information on the rating plate agrees with the power supply. If not, contact an electrician.
- Always use a correctly installed shockproof socket.
- Do not use multi-plug adapters and extension cables. There is a risk of fire.
- Make sure not to cause damage to the mains plug and to the mains ca-

ble. Contact Service or an electrician to change a damaged mains cable.

- Connect the mains plug to the mains socket only at the end of the installation. Make sure that there is access to the mains plug after the installation.
- Do not pull the mains cable to disconnect the appliance. Always pull the mains plug.
- **Only for UK and Ireland.** The appliance has a 13 amp mains plug. If it is necessary to change the fuse in the mains plug, use a 13 amp ASTA (BS 1362) fuse.

USE



WARNING!
Risk of injury.

- Use this appliance in a household environment.
- Do not change the specification of this appliance.
- Put knives and cutlery with sharp points in the cutlery basket with the points down or in a horizontal position.
- Do not keep the appliance door open without supervision to prevent to fall on it.
- Do not sit or stand on the open door.
- Dishwasher detergents are dangerous. Obey the safety instructions on the detergent packaging.

- Do not drink and play with the water in the appliance.
- Do not remove the dishes from the appliance until the programme is completed. There can be detergent on the dishes.



WARNING!

Risk of electrical shock, fire or burns.

- Do not put flammable products or items that are wet with flammable products in, near or on the appliance.
- Do not use water spray and steam to clean the appliance.
- The appliance can release hot steam if you open the door while a programme operates.

DISPOSAL



WARNING!

Risk of injury or suffocation.

- Disconnect the appliance from the mains supply.
- Cut off the mains cable and dispose of it.
- Remove the door catch to prevent children and pets to get closed in the appliance.

PRODUCT DESCRIPTION

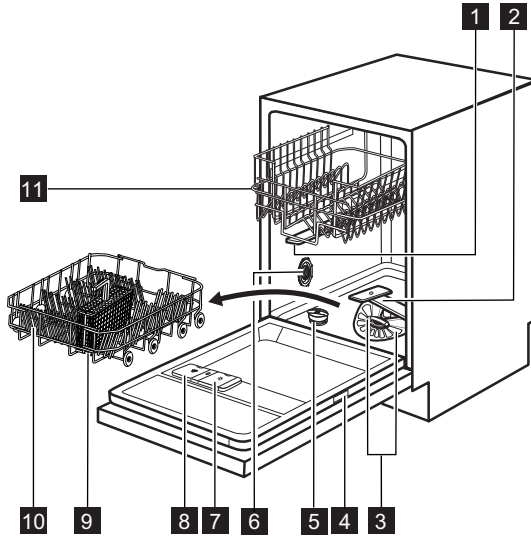

- 1** Upper spray arm
- 2** Lower spray arm
- 3** Filters
- 4** Rating plate
- 5** Salt container
- 6** Water hardness dial
- 7** Rinse aid dispenser
- 8** Detergent dispenser
- 9** Cutlery basket
- 10** Lower basket

- 11** Upper basket

LIGHT BEAM

- When a programme operates, a red light beam shows on the floor below the appliance door. When the programme is completed, the red light changes to a green light.
- When the appliance has a malfunction, the red light beam flashes.

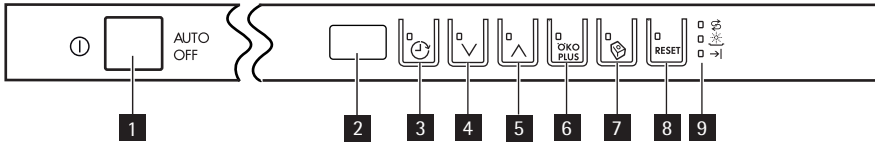

CONTROL PANEL



- | | | | |
|----------|-------------------------|----------|-----------------|
| 1 | On/off button | 6 | ÖKO PLUS button |
| 2 | Display | 7 | Multitab button |
| 3 | Delay button | 8 | RESET button |
| 4 | Programme button (down) | 9 | Indicators |
| 5 | Programme button (up) | | |

Indicators	
	Salt indicator. This indicator is off while the programme operates.
	Rinse aid indicator. This indicator is off while the programme operates.
	End indicator.

PROGRAMMES

Programme	Type of soil Type of load	Programme phases	Options
1 AUTO 45°-70° ¹⁾	All Crockery, cutlery, pots and pans	Prewash Wash 45 °C or 70 °C Rinses Dry	ÖKO PLUS
2 PRO 70° ²⁾	Heavy soil Crockery, cutlery, pots and pans	Prewash Wash 70 °C Rinses Dry	ÖKO PLUS
3 Extra SILENT ³⁾ 50°	Normal soil Crockery and cutlery	Prewash Wash 50 °C Rinses Dry	
4 Quick 30MIN ⁴⁾ 60°	Fresh soil Crockery and cutlery	Wash 60 °C Rinse	
5 ECO 50° ⁵⁾	Normal soil Crockery and cutlery	Prewash Wash 50 °C Rinses Dry	ÖKO PLUS
6 Quick 50MIN 55°	Light soil Crockery and cutlery	Wash 55 °C Rinses	
7  45°	Normal or light soil Delicate crockery and glassware	Wash 45 °C Rinses Dry	ÖKO PLUS
8   ⁶⁾	All	Prewash	

1) The appliance senses the type of soil and the quantity of items in the baskets. It automatically adjusts the temperature and quantity of the water, the energy consumption and the programme duration.

2) This programme has a high temperature rinsing phase for better hygiene results. During the rinsing phase, the temperature stays at 70 °C for 10 to 14 minutes.



3) This is the most silent washing programme. The pump works at a very low speed to decrease the level of noise. Because of the low speed, the programme duration is long.

4) With this programme you can wash a load with fresh soil. It gives good washing results in a short time.

5) This is the standard programme for test institutes. With this programme you have the most efficient use of water and energy consumption for crockery and cutlery with normal soil. Refer to the supplied leaflet for test information.

6) Use this programme to quickly rinse the dishes. This prevents the remaining food to bond on the dishes and bad odours to come out from the appliance.
Do not use detergent with this programme.

Consumption values

Programme ¹⁾	Duration (min)	Energy (kWh)	Water (l)
1 AUTO 45°-70°	80 - 140	0.7 - 1.3	8 - 14
2 PRO 70°	130 - 150	1.1 - 1.2	10 - 11
3 Extra SILENT 50°	180 - 200	0.9 - 1.0	8 - 9
4 Quick 30MIN 60°	30	0.8	7
5 ECO 50°	170 - 190	0.7 - 0.8	8 - 9
6 Quick 50MIN 55°	40 - 50	0.8 - 0.9	8 - 9
7  45°	70 - 80	0.6 - 0.7	9 - 10
8 	10	0.01	3

¹⁾ The water pressure and temperature, the variations of the mains supply, the options and the quantity of dishes can change the programme duration and the consumption values.

OPTIONS

MULTITAB FUNCTION

Activate this function only when you use the combi detergent tablets. This function deactivates the flow of rinse aid and salt. The related indicators are off.

The programme duration can increase.

Activating the multitab function

 Activate or deactivate the multitab function before the start of a programme. You cannot activate or deactivate this function when a programme operates.

1. Press the on/off button to activate the appliance.
2. Make sure that the appliance is in setting mode. Refer to 'SETTING AND STARTING A PROGRAMME'.
3. Press the multitab button, the multitab indicator comes on.

 The function stays on until you deactivate it. Press the multitab button, the multitab indicator goes off.

If you stop to use the combi detergent tablets, before you start to use separately detergent, rinse aid and dishwasher salt, do these steps:

1. Deactivate the multitab function.
2. Set the water softener to the highest level.
3. Make sure that the salt container and the rinse aid dispenser are full.
4. Start the shortest programme with a rinsing phase, without detergent and without dishes.
5. Adjust the water softener to the water hardness in your area.
6. Adjust the released quantity of rinse aid.

ÖKO PLUS

This function decreases the temperature in the drying phase. The energy consumption decreases by 25%. The dishes can be wet at the end of the programme. We recommend that you keep the door ajar and let the dishes dry.

ACOUSTIC SIGNALS

The acoustic signals operate in these conditions:

- The programme is completed.
- The level of the water softener is adjusted electronically.
- The appliance has a malfunction.

 Factory setting: on. You can deactivate the acoustic signals.

Deactivating the acoustic signals

1. Press the on/off button to activate the appliance.
2. Make sure that the appliance is in setting mode. Refer to 'SETTING AND STARTING A PROGRAMME'.
3. Press and hold buttons (4) and (5) at the same time until the indicators of buttons (3), (4) and (5) flash.
4. Press button (5),
 - The indicators of buttons (3) and (4) go off.
 - The indicator of button (5) continues to flash.
 - The display shows the setting of the acoustic signals.

<i>lb</i>	On
<i>Ob</i>	Off

5. Press button (5) to change the setting
6. Deactivate the appliance to confirm.

BEFORE FIRST USE

1. Make sure that the set level of the water softener agrees with the water hardness in your area. If not, adjust the water softener. Contact your local water authority to know the water hardness in your area.
2. Fill the salt container.
3. Fill the rinse aid dispenser.
4. Open the water tap.
5. Processing residues can stay in the appliance. Start a programme to remove them. Do not use detergent and do not load the baskets.



If you use the combi detergent tablets, activate the multitab function. These tablets contain detergent, rinse aid and other added agents. Be sure that these tablets are applicable to the water hardness in your area. Refer to the instructions on the packaging of the products.

ADJUSTING THE WATER SOFTENER

Hard water contains a high quantity of minerals that can cause damage to the appliance and bad washing results. The water softener neutralises these minerals.

The dishwasher salt keeps the water softener clean and in good conditions. Refer to the table to adjust the water softener to the right level. It makes sure that the water softener uses the correct quantity of dishwasher salt and water.



You must adjust the water softener manually and electronically.

Water hardness				Water softener adjustment	
German degrees (°dH)	French degrees (°fH)	mmol/l	Clarke degrees	Manual	Electronic
51 - 70	91 - 125	9.1 - 12.5	64 - 88	2 ¹⁾	10
43 - 50	76 - 90	7.6 - 9.0	53 - 63	2 ¹⁾	9
37 - 42	65 - 75	6.5 - 7.5	46 - 52	2 ¹⁾	8
29 - 36	51 - 64	5.1 - 6.4	36 - 45	2 ¹⁾	7
23 - 28	40 - 50	4.0 - 5.0	28 - 35	2 ¹⁾	6
19 - 22	33 - 39	3.3 - 3.9	23 - 27	2 ¹⁾	5 ¹⁾
15 - 18	26 - 32	2.6 - 3.2	18 - 22	1	4
11 - 14	19 - 25	1.9 - 2.5	13 - 17	1	3
4 - 10	7 - 18	0.7 - 1.8	5 - 12	1	2
< 4	< 7	< 0.7	< 5	1 ²⁾	1 ²⁾

¹⁾ Factory position.

²⁾ Do not use salt at this level.

Manual adjustment

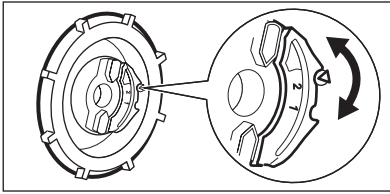

Turn the water hardness dial to the position 1 or 2.

Electronic adjustment

1. Press the on/off button to activate the appliance.
 2. Make sure that the appliance is in setting mode. Refer to 'SETTING AND STARTING A PROGRAMME'.
 3. Press and hold buttons (4) and (5) at the same time until the indicators of buttons (3), (4) and (5) flash.
 4. Press button (3).
 - The indicators of buttons (4) and (5) go off.
 5. Press button (3) again and again to change the setting.
 6. Deactivate the appliance to confirm.
- The indicator of button (3) continues to flash.
 - The acoustic signals operate. Example: five intermittent acoustic signals = level 5.
 - The display shows the setting of the water softener. Example: **5 L** = level 5.

FILLING THE SALT CONTAINER

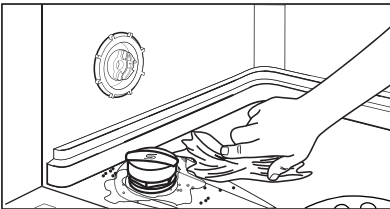
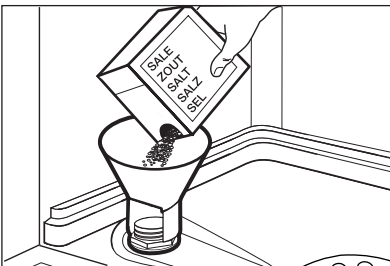

CAUTION!

Only use dishwasher salt. Other products can cause damage to the appliance. Water and salt can come out from the salt container when you fill it. Risk of corrosion. To prevent it, after you fill the salt container, start a programme.

1. Turn the cap counterclockwise and open the salt container.
2. Put 1 litre of water in the salt container (only for the first time).
3. Fill the salt container with dishwasher salt.
4. Remove the salt around the opening of the salt container.
5. Turn the cap clockwise to close the salt container.

FILLING THE RINSE AID DISPENSER

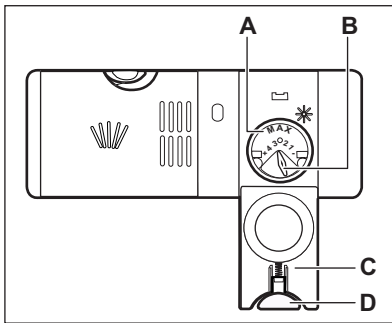

CAUTION!

Only use rinse aid for dishwashers. Other products can cause damage to the appliance.



The rinse aid, during the last rinsing phase, helps to dry the dishes without streaks and stains.

1. Press the release button (D) to open the lid (C).
2. Fill the rinse aid dispenser (A), no more than the mark 'max'.
3. Remove the spilled rinse aid with an absorbent cloth to prevent too much foam.
4. Close the lid. Make sure that the release button locks into position.



You can turn the selector of the released quantity (B) between position 1 (lowest quantity) and position 4 (highest quantity).

DAILY USE

1. Open the water tap.
2. Press the on/off button to activate the appliance. Make sure that the appliance is in setting mode. Refer to 'SETTING AND STARTING A PROGRAMME'.
 - If the salt indicator is on, fill the salt container.
 - If the rinse aid indicator is on, fill the rinse aid dispenser.
3. Load the baskets.
4. Add the detergent.
5. Set and start the correct programme for the type of load and soil.

LOADING THE BASKETS



Refer to the supplied leaflet with examples of the load of the baskets.

- Only use the appliance to wash items that are dishwasher-safe.
- Do not put in the appliance items made of wood, horn, aluminium, pewter and copper.
- Do not put in the appliance items that can absorb water (sponges, household cloths).
- Remove remaining food from the items.
- Make soft the remaining burned food on the items.
- Put hollow items (cups, glasses and pans) with the opening down.
- Make sure that cutlery and dishes do not bond together. Mix spoons with other cutlery.
- Make sure that glasses do not touch other glasses.
- Put small items in the cutlery basket.
- Put light items in the upper basket. Make sure that the items do not move.
- Make sure that the spray arms can move freely before you start a programme.

USING THE DETERGENT

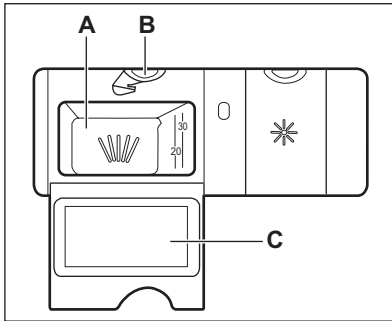

CAUTION!

Use only detergents for dishwashers.

1. Press the release button (B) to open the lid (C).
2. Put the detergent in the compartment (A).
3. If the programme has a prewash phase, put a small quantity of detergent on the inner part of the appliance door.
4. If you use detergent tablets, put the tablet in the compartment (A).
5. Close the lid. Make sure that the release button locks into position.



Do not use more than the correct quantity of detergent. Refer to the instructions on the detergent packaging.



Detergent tablets do not fully dissolve with short programmes and detergent residues can stay on the dishes. We recommend that you use detergent tablets with long programmes.

SETTING AND STARTING A PROGRAMME

Setting mode

The appliance must be in setting mode to accept some operations.

The appliance is in setting mode when, after the activation:

- The display shows two horizontal status bars.

If the control panel shows other conditions, press **RESET** until the appliance is in setting mode.

Starting a programme without delay start

1. Open the water tap.

2. Press the on/off button to activate the appliance. Make sure that the appliance is in setting mode.
3. Set the programme.
 - The related programme number flashes in the display.
4. If you want, you can set the options.
5. Close the appliance door. The programme starts.
 - If you open the door, the display shows the programme duration that decreases with steps of 1 minute.

Starting a programme with delay start

1. Set the programme.
2. Press the delay button again and again until the display shows the de-

lay time you want to set (from 1 to 24 hours).

- The delay time flashes in the display.
 - The delay indicator is on.
3. Close the appliance door. The countdown starts.
 - If you open the door, the display shows the countdown of the delay start that decreases with steps of 1 hour.
 - When the countdown is completed, the programme starts.

Opening the door while the appliance operates

If you open the door, the appliance stops. When you close the door, the appliance continues from the point of interruption.

Cancelling the delay start while the countdown operates

1. Open the appliance door.
2. Press the delay button again and again until the display shows the programme number.
3. Close the appliance door. The programme starts.

Cancelling the programme

Press **RESET** until:

- The display shows two horizontal status bars.



Make sure that there is detergent in the detergent dispenser before you start a new programme.

At the end of the programme

When the programme is completed, an intermittent acoustic signal operates.

1. Open the appliance door.
 - The end indicator is on.
 - The display shows **0**.
2. Press the on/off button to deactivate the appliance.
3. Close the water tap.



If you do not press the on/off button, the **AUTO OFF** device automatically deactivates the appliance after some minutes. This helps to decrease the energy consumption.

- For better drying results, keep the appliance door ajar for some minutes.
- Let the dishes become cold before you remove them from the appliance. Hot dishes can be easily damaged.
- First remove the items from the lower basket, then from the upper basket.



There can be water on the sides and on the door of the appliance. Stainless steel becomes cool more quickly than the dishes.

CARE AND CLEANING



WARNING!

Before maintenance, deactivate the appliance and disconnect the mains plug from the mains socket.



Dirty filters and clogged spray arms decrease the washing results.

Make a check regularly and, if necessary, clean them.

CLEANING THE FILTERS

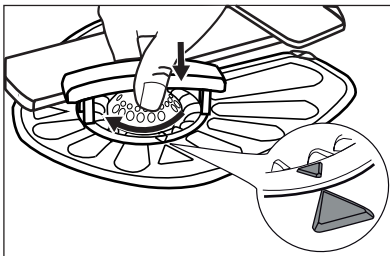
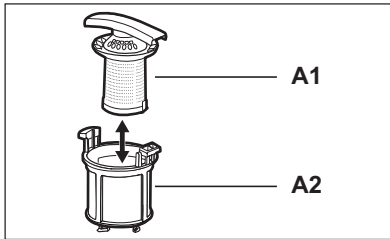
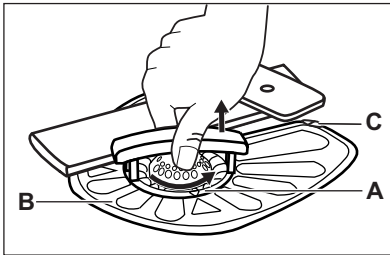

1. Turn the filter **(A)** counter-clockwise and remove it.
2. To disassemble the filter **(A)**, pull apart **(A1)** and **(A2)**.
3. Remove the filter **(B)**.
4. Wash the filters with water.
5. Put the filter **(B)** to its initial position. Make sure that it assembles correctly under the two guides **(C)**.
6. Assemble the filter **(A)** and put it into position in filter **(B)**. Turn it clockwise until it locks.



An incorrect position of the filters can cause bad washing results and damage to the appliance.

CLEANING THE SPRAY ARMS

Do not remove the spray arms. If the holes in the spray arms are clogged, remove remaining parts of soil with a thin pointed object.

Only use neutral detergents. Do not use abrasive products, abrasive cleaning pads or solvents.

EXTERNAL CLEANING

Clean the appliance with a moist soft cloth.

TROUBLESHOOTING

The appliance does not start or it stops during operation.

First try to find a solution to the problem (refer to the table). If not, contact Service.

With some problems, the display shows an alarm code:

- **,10** - The appliance does not fill with water.

- **,20** - The appliance does not drain the water.
- **,30** - The anti-flood device is on.



WARNING!

Deactivate the appliance before you make the checks.

Problem	Possible cause	Possible solution
The programme does not start.	The mains plug is not connected in the mains socket.	Connect the mains plug.
	The appliance door is open.	Close the appliance door.
	The fuse in the fuse box is damaged.	Replace the fuse.
	The delay start is set.	Cancel the delay start or wait for the end of the countdown.
The appliance does not fill with water.	The water tap is closed.	Open the water tap.
	The water pressure is too low.	Contact your local water authority.
	The water tap is clogged or there is limescale on it.	Clean the water tap.
	The filter in the water inlet hose is clogged.	Clean the filter.
	The water inlet hose has a kink or a bend.	Make sure that the position of the hose is correct.
	The anti-flood device is on. There are water leakages in the appliance.	Close the water tap and contact Service.
The appliance does not drain the water.	The sink spigot is clogged.	Clean the sink spigot.
	The water drain hose has a kink or a bend.	Make sure that the position of the hose is correct.

After the checks are completed, activate the appliance. The programme continues from the point of interruption.

If the problem occurs again, contact Service.

If the display shows other alarm codes, contact Service.

THE WASHING RESULTS AND DRYING RESULTS ARE NOT SATISFACTORY

Problem	Possible cause	Possible solution
The dishes are not clean.	The filters are clogged.	Clean the filters.
	The filters are not correctly assembled and installed.	Make sure that the filters are correctly assembled and installed.
	The spray arms are clogged.	Remove remaining soil with a thin pointed object.
	The programme was not applicable for the type of load and soil.	Make sure that the programme is applicable for the type of load and soil.
	Incorrect position of the items in the baskets. Water could not wash all items.	Make sure that the position of the items in the baskets is correct and that the water can easily wash all items.
	The spray arms could not turn freely.	Make sure that the position of the items in the baskets is correct and does not cause the blockage of the spray arms.
	The quantity of detergent was not sufficient.	Make sure that you add the correct quantity of detergent in the dispenser before you start a programme.
Limescale particles on the dishes.	There was no detergent in the detergent dispenser.	Make sure that you add detergent in the dispenser before you start a programme.
	The salt container is empty.	Make sure that there is dishwasher salt in the salt container.
	The set level of the water softener is incorrect.	Make sure that the set level of the water softener agrees with the water hardness in your area.
	The cap of the salt container is loose.	Tighten the cap.
	Whitish streaks and stains or bluish layers on glasses and dishes.	The released quantity of rinse aid is too much.

Problem	Possible cause	Possible solution
	The quantity of detergent was too much.	Make sure that you add the correct quantity of detergent in the dispenser before you start a programme.
Dry water drop stains on glasses and dishes.	The released quantity of rinse aid was not sufficient .	Increase the released quantity of rinse aid.
	The quality of the detergent can be the cause.	Try a different brand of detergent.
The dishes are wet.	<ul style="list-style-type: none"> • The programme had no drying phase. • The programme had a low temperature drying phase. 	For better drying results, keep the door ajar for some minutes.
The dishes are wet and matt.	The rinse aid dispenser is empty.	Make sure that there is rinse aid in the rinse aid dispenser.
	The quality of the rinse aid can be the cause.	Try a different brand of rinse aid.
	The quality of the combi detergent tablets can be the cause.	<ul style="list-style-type: none"> • Try a different brand of combi detergent tablets. • Activate the rinse aid dispenser and use the rinse aid together with the combi detergent tablets.

Activating the rinse aid dispenser with the multitab function activated

1. Press the on/off button to activate the appliance.
2. Make sure that the appliance is in setting mode. Refer to 'SETTING AND STARTING A PROGRAMME'.
3. Press and hold buttons (4) and (5) at the same time until the indicators of buttons (3), (4) and (5) flash.
4. Press button (4).
 - The indicators of buttons (3) and (5) go off.

- The indicator of button (4) continues to flash.
- The display shows the setting of the rinse aid dispenser.

<i>0d</i>	Off
<i>1d</i>	On

5. Press button (4) to change the setting.
6. Deactivate the appliance to confirm.
7. Adjust the released quantity of rinse aid.
8. Fill the rinse aid dispenser.

TECHNICAL INFORMATION

Dimensions	Width / Height / Depth (mm)	446 / 818 - 898 / 550
Electrical connection	Refer to the rating plate.	
Water supply pressure	Min. / max. (bar / MPa)	(0.5 / 0.05) / (8 / 0.8)

Water supply ¹⁾	Cold water or hot water ²⁾	max. 60 °C
Capacity	Place settings	9

¹⁾ Connect the water inlet hose to a water tap with a 3/4" thread.

²⁾ If the hot water comes from alternative sources of energy, (e.g. solar panels, aeolian energy), use the hot water supply to decrease energy consumption.

www.aeg.com/shop

117929050-A-192011

